

Premium Sweepers

34 | TR v2.0

FACTORYCAT®

Handmade in U.S.A. - Est 1986



*Images could include non-standard options. Subject to change without notice.

Family-Owned & Operated



Scrubbers

Sweepers

Choose Your TR Central Command

2010's technology

Touch Screen Controller

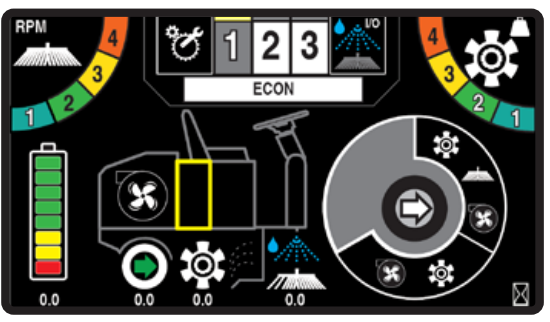

Actuators



2000's technology

Gauges & Toggles



Manual Levers

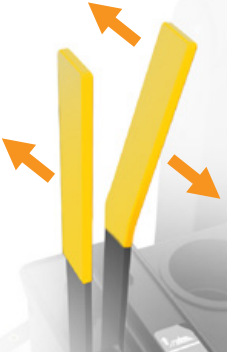

Applications



Saw Mills

Sweepers are crucial in saw mills for efficiently removing sawdust and wood chips, essential for a safe working environment. They quickly clear both fine dust and larger chips, reducing fire risks and ensuring smooth machine operation. Their regular use helps maintain a clear, safe floor, crucial in a busy mill. Plus, these sweepers save time and effort, boosting productivity.



Fabrication Shops

In fabrication shops having a sweeper plays a vital role in efficiently collecting metal shavings and debris, essential for maintaining a clean and safe working environment. Their advanced brushes and vacuum capabilities are highly effective in capturing both fine particles and larger fragments, preventing equipment malfunctions and safety hazards. The consistent use of these sweepers ensures the preservation of cleanliness in the shop, crucial for the quality and integrity of fabrication processes.



Foundries

In foundries, where handling molten metal and intense heat is the norm, ride-on sweepers are crucial for managing the unique debris, like metal scraps and foundry sand. These machines effectively clean up the hazardous waste and metal dust, helping to prevent accidents and maintain a safe working environment. Their robust design is tailored to withstand the harsh conditions of a foundry, ensuring durability and effectiveness. Regular use of these sweepers keeps the floors clear, reducing downtime and enhancing overall productivity in such a high-demand setting.

34

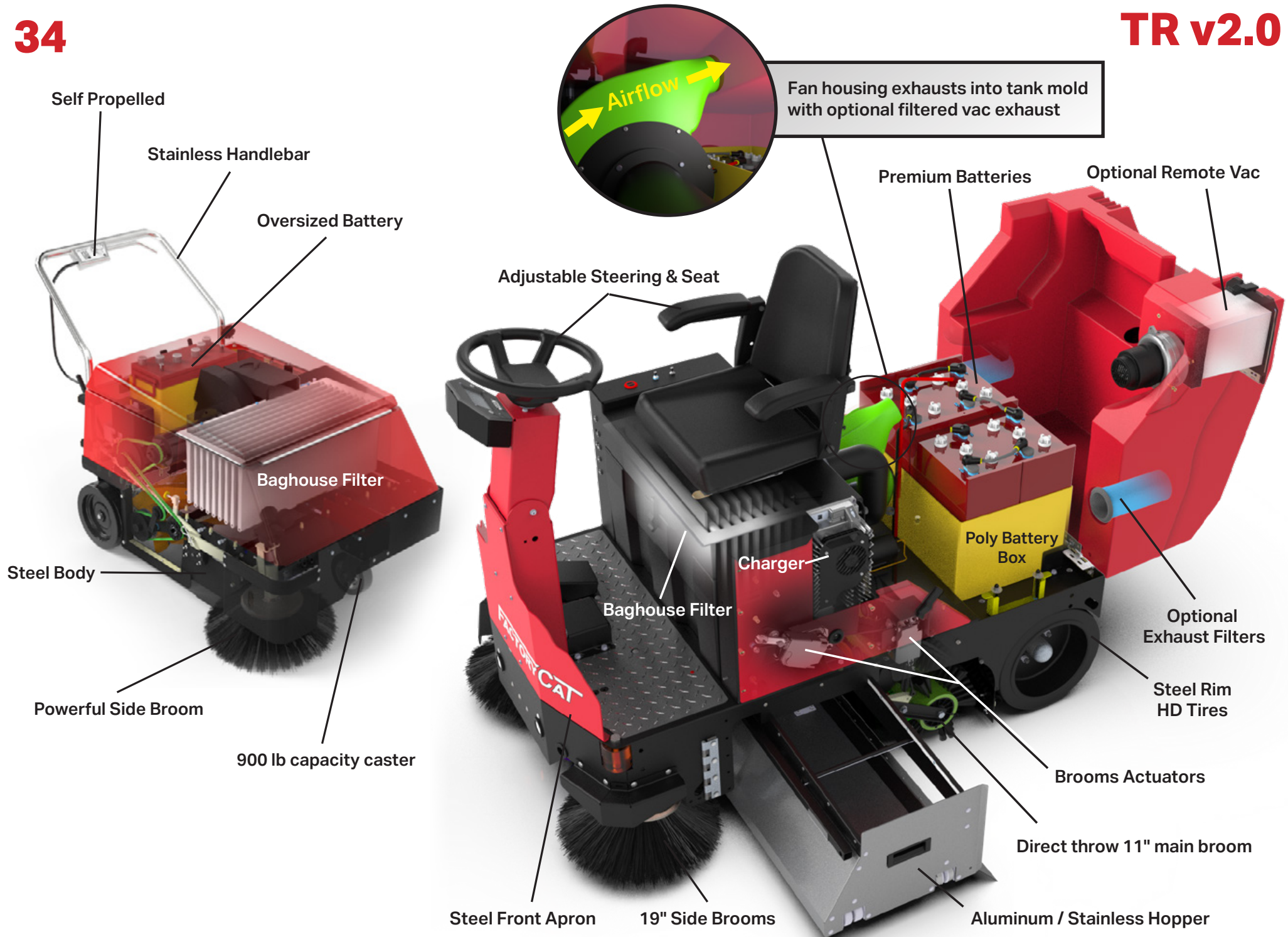

You Be The Judge

Optional Exhaust Filters

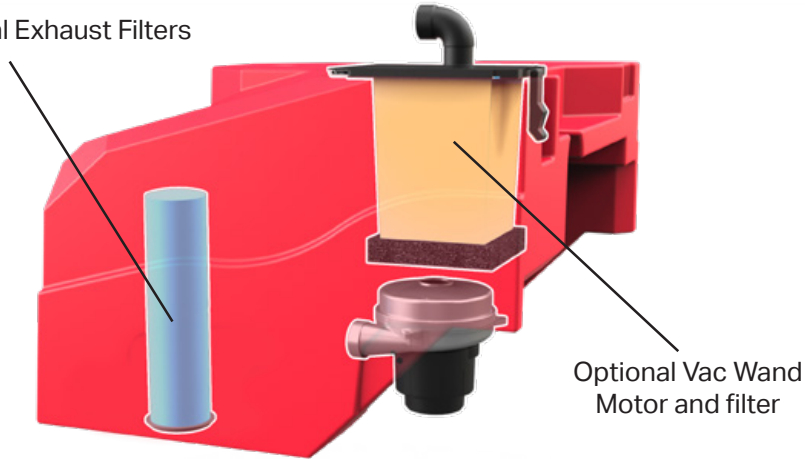

Patent Pending Hood

- Main fan housing exhaust into hoods interior reducing noise levels. The optional secondary exhaust filters raise air quality to even higher levels, benefiting the operator and others nearby.
- An optional remote hand vac wand system is molded into the hood, eliminating bulky and visibility impairing secondary boxes. A dedicated 6.5" vac motor pulls loose debris into a paper vacuum bag, allowing operator to dispose without contacting litter.

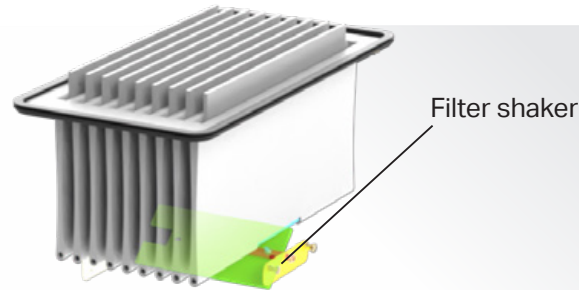

Baghouse Filter

- Our polymer felt baghouse filter offers longer life and therefore reduced cost compared to cheaper paper panel filters. Similar to what is found in large street sweepers, our baghouse filters have superior dust capacity and lower the chances the main broom creates dust while sweeping.

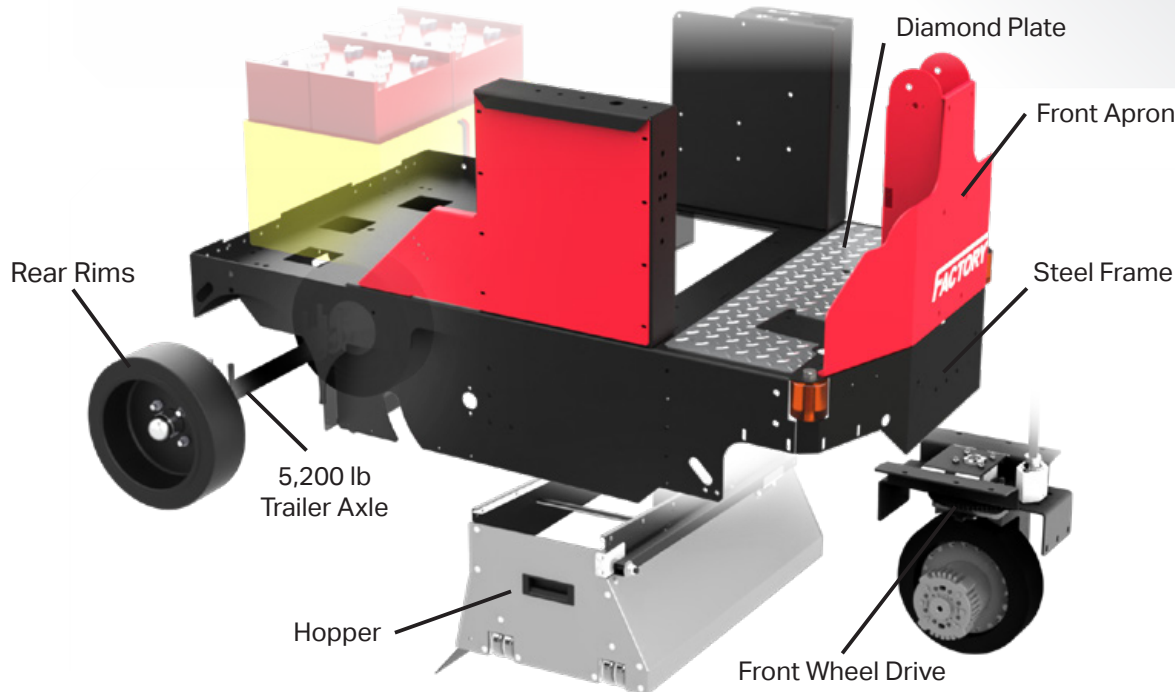

Heavy Steel Construction

- The thick steel frame supports the oversized battery pack and is supported by a 5,200 lb trailer axle with steel rimmed tires. Large tie down points for transport and steel apron offer the operator foot protection. Instead of cheaper grip tape that wear out quickly our TR uses aluminum Diamond plate for the high traffic footwell.

34 & TR Shared Options



Grey Tires

- Non-marking tires available for more sensitive floor coverings or coatings.

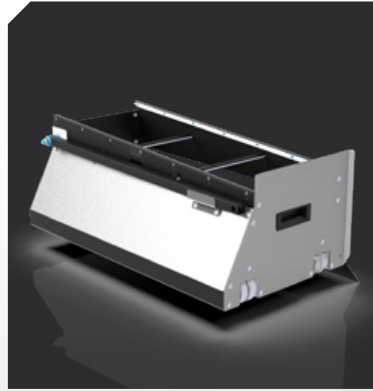

Stainless Hopper

- highest corrosion resistance for applications with harsh debris or operational floor environment (road salt, fertilizer production, chemical packaging, etc..)

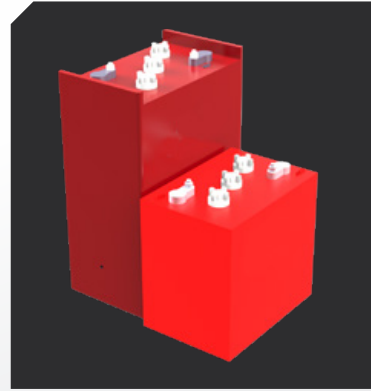

Batteries

- Wide range of battery sizes and types to match individual customer runtime and maintenance expectations.



HD Bumpers

- Superior protection against collisions with steel racking, posts or other industrial obstacles.

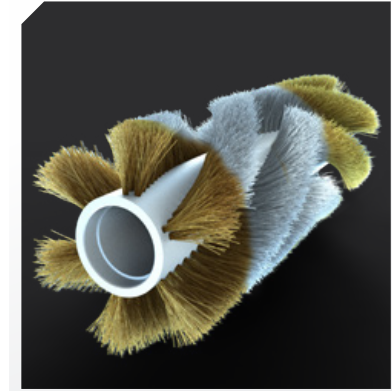

Broom Fiber Selection

- Range of fibers from softest (tennis courts) through medium (dust control) and up to toughest (outdoors).

TR Only Options



Overhead Guard

- Offers operator protection from falling objects and ideal in modern high ceiling distribution centers.

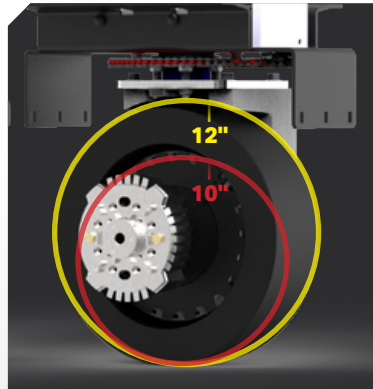

12" Front Wheel Drive

- Heavy duty larger drive tire



Secondary Exhaust Filters

- Provide additional dust control and are easily removed for cleaning when needed.

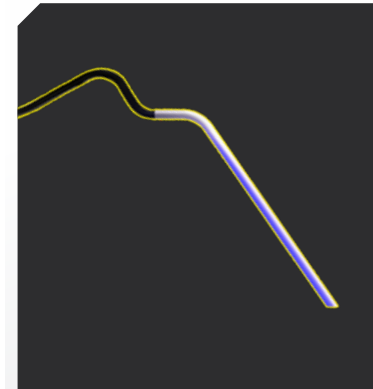

Vac Wand

- Extends the operators cleaning while seated or from the floor to clean under racking. Suitable for loose dry debris, not fluid spills.

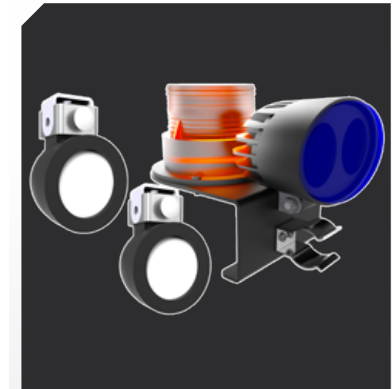

Lights / Strobes

- Operator controlled dual led headlights, or key switch activated flashing strobe and forward alerting floor spotlight.

Our Family's American Dream

RPS has been family owned from its inception in 1986, and proudly builds in Wisconsin (USA). The company has grown over the last 35-years with a strong group of executives including the 2nd generation of family owners who started in the shop as youngsters.



Authorized Distributor

Assembled By Hand

Our American workforce hand builds each machine with components sourced over 95% from American suppliers. We routinely pay more for these domestically supplied components required to build a superior product. All design, prototyping, production and testing is done in-house where we can best control quality.

MODEL	WALK BEHIND 34	RIDER TR v2.0
BODY CONSTRUCTION / DIMENSIONS		
Chassis Construction:	1/8" (3 mm) Powder Coated Steel	3/16" (5 mm) Powder Coated Steel
Front Wheel (Diameter x Width):	6" x 2" (15 x 5 cm)	10" x 3" (25 x 8 cm) Optional 12" x 4" (31 x 10 cm)
Rear Wheels (Diameter x Width):	(2x) 10" x 2" ([2x] 25 x 5 cm)	(2x) 14" x 5" ([2x] 36 x 13 cm)
Size (L x W x H):	58" x 31" x 38" (147 x 79 x 96 cm)	64" x 37" x 50" (163 x 94 x 140 cm)
Weight (w/ Standard Batteries):	425 - 475 lbs (193 - 215 kg)	1,115 - 1,165 lbs (506 - 528 kg)
SWEEPING SYSTEM		
Broom (Diameter x Length):	10" x 26" (25 - 66 cm)	11" x 32" (25 x 81 cm)
Broom Power / Speed:	1.0 hp / 400 rpm (746 watts)	1.0 hp / 435 rpm (746 watts)
Side Broom Size:	(1x) 17" (43 cm)	(2x) 19" ([2x] 43 cm)
Hopper Capacity:	2.0 cubic ft. (56 liters)	4.2 cubic ft. (116 liters)
POWER SYSTEM		
System Power:	12 VDC - 175 ah	24 VDC - 240 ah
Optional Battery:	215 ah AGM	Up to / 420 ah WET / 390 ah AGM
Run Time:	Up to 5 Hours**	Up to 5 Hours**
<small>**Run times are based on continuous sweeping run times.</small>		
DRIVE SYSTEM:		
Power:	1.0 hp - All Gear / Sealed (745 watts)	1.0 hp - All Gear / Sealed (745 watts)
Speed Control:	0 - 237.6 ft/min / 0 - 2.7 mph (0 - 72.4 m/min / 0 - 4.3 km/h)	0 - 308 ft/min / 0 - 3.5 mph (0 - 93.9 m/min / 0 - 5.6 km/h)
FILTERING SYSTEMS:		
Filtering Material:	Polymer Felt/Baghouse	Polymer Felt/Baghouse
Filter Rating:	1 Micron	1 Micron
Size:	5,192 sq. inches (3.35 sqm)	5,192 sq. inches (3.35 sqm)
Vacuum Specs (Airflow):	250 cfm	280 cfm
GENERAL:		
Cleaning Width:	34" (86 cm)	48" (121 cm)
Decibels:	61 dBA***	65 dB***
<small>***Decibel levels per ISO 11201 as recommended by the American Association of Cleaning Equipment Manufacturers & OSHA</small>		
Productivity - Theoretical:	Up to 21,316 sqft (1,980 sqm)****	Up to 75,000 sqft (6,968 sqm)****
<small>****Productivity is based off of ISSA 2010 Cleaning Times</small>		
Productivity - Practical:	Up to 17,647 sqft (1,639 sqm)****	Up to 59,406 sqft (5,519 sqm)****
<small>****Productivity is based off of ISSA 2010 Cleaning Times</small>		